

### < Automatic burner control unit >

MONO – DOUBLE ELECTRODE / UV-SENSOR FLAME DETECTION



# SAITEK srl

[www.saitek.it](http://www.saitek.it)      [info@saitek.it](mailto:info@saitek.it)

Casalgrande (RE) ITALY Tel . +39 0522 848211 Fax +39 0522 849070







# ATTENTION!

If assembly, adjustment, modification, use or maintenance they are not performed correctly, they can occur injury or damage.

Please read the instructions first to use the product to come installed according to regulations in force in the countries of installation.

		<b>SAITEK srl</b> Via IV Novembre 4 - 42013 CASALGRANDE (RE) ITALY	
<i>mod.</i> <a href="http://www.saitek.it">www.saitek.it</a>			
<b>CF5 -P001</b>		<b>LO 2023 10</b>	
			
<i>Spec.</i> According to EN 298			
V ~ 230	Wt T 5 sec		
HZ 50/60	Ig T 5 sec		
W 15	Ig ED 100%		
IP 40	Sc T 1 sec		
°C 0/+60	Sens. 1,2 µA		
<i>s/n</i> ???????			
<b>ATTENZIONE!!!!</b> SCOLLEGARE L'ALIMENTAZIONE PRIMA DI APRIRE IL COPERCHIO			
		<b>WARNING!!!!</b> DISCONNECT POWER SUPPLY BEFORE OPEN THE COVER	

## INSTRUCTIONS FOR USE

Read carefully and preserve this use and maintenance reference manual.

### ATTENTION!!!

Any indication and operation indicated in the present manual shall be carried out only by authorized and qualified personnel in charge.

Improper and incorrect assembly, adjustment, modification, use or maintenance can cause serious damages and accidents to persons and things.

Read carefully the instructions before installing the appliance. The assembly shall be in compliance with the regulations in force.

In order to prevent accidental electrocutions it is recommended you disconnect the electric current before opening the appliance.

Before supplying power check the value reported on the tag.

## CONFORMIT

The manufacturer declares that:

- **CFS** has been designed, realized and tested in compliance with the European Rule **EN298** relative to "Control and safety automatic systems for gas burners and gas appliances with or without fan.
- **CFS** it also complies with the requirements essential provisions set out in the following Directives:
  - 2006/42 together with the paragraphs relevant of EN 746,
  - 2014/35/EU together with the regulations relevant,
  - 2014/30/EU together with the regulations relevant information relating to disturbances electromagnetic
- This device shall be integrated with a valve-proving system according to

EN 1643:2022 that checking the leakage during each burner cycle

- EMC emission requirements shall be tested after the incorporation into the equipment

## APPLICATIONS

**CFS** flame control appliance directly lights and controls intermittent gas burners, **or rather burners that shall be turned off at least once in the 24 hours.**

The burner is checked by an ionization electrode.

For grounded grids.

With a single restart due to flame put out.

**CFS** can be applied directly to the burner in industrial thermal processes for metals, glass, ceramic, plastic, chemical, etc...., where there is no need of a pre-ventilation before turning it on.

Besides it can be applied on atmospheric burners for general heating.

### ATTENTION

Avoid presence of condensation inside the box and on the card surface..

## TECHNICAL SPECIFICATIONS

- Data relating to power supply characteristics (V ~ / Hz / W), working temperature (° C), IP00 protection class, discharge time (lg T), safety (Sc) and detection threshold ( Sens.), See the applied label.
- Voltage supplied to the loads the same to the supply voltage.
- **Detection with 2 electrodes, 1 electrode or UV lamp**
- Possibility of using both electronic and traditional ignition transformers.
- LED display: on, block, discharge and detection.
- Alarm contact in exchange: closed when in block, closed when in flame detection.

## SCHEDA VISUALIZZATRICE

The CF5 flame control is supplied together with the additional display card STK035. This offers the opportunity to control the functionality of the equipment in a more effective and immediate way. This is made possible by the four LEDs for displaying the flame level, the LED for controlling the safety systems and the LED for remote unlocking. The latter also remains slightly lit when the main switch is in position 0 to indicate presence of voltage (**N.B. can only be used by authorized personnel keeping under control the burner to be turned on**).

## MONTAGGIO

- Mounting position as desired
- Assembly of the fixed rear part, through 4 preformed holes to be removed by pressure.

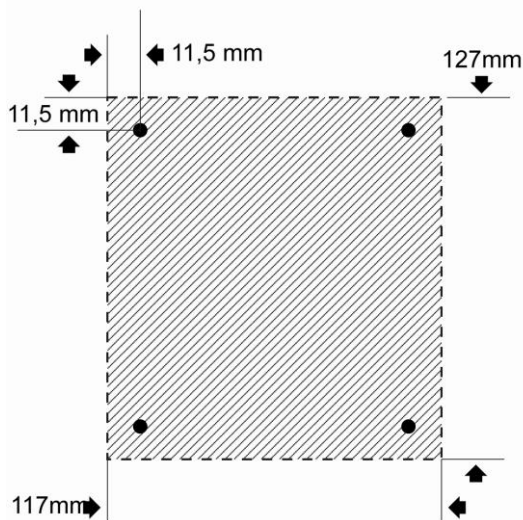

- Dimensions 117 x 127 x 122 mm
- Prepared to pipe fixing collars
- **CF5** can be supplied already wired, otherwise make the necessary holes only in the rear part and use cable glands that guarantee at least the same degree of IP protection declared.

## CAVI CONSIGLIATI

**IONIZATION:** Maximum length 10 meters with recommended section 1 mm. Laying away from sources of disturbance, avoid external electrical influences.

**IGNITION:** as specified by the manufacturer of the ignition transformer. Recommended conductor diameter 1mm. Lay individually away from metal parts.

## CABLAGGIO

Remove power from the system.

In three-phase systems, use the same phase on the inputs. There must be no voltage present in the output for the solenoid valve.

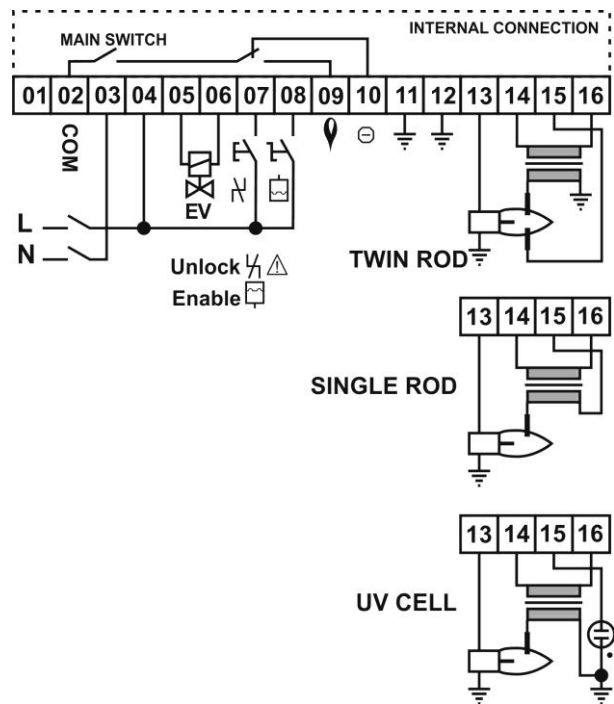

The enabling command of the CF5 that comes from the safety sequence (all the main control devices for safety purposes such as thermostats, GASmin, GASmax, leakage control, prewash, etc. ...) must be voltage-free contacts.

The output voltage for the solenoid valve and the ignition transformer (included if required) is the same as the supply voltage.

The current max. for solenoid valve and ignition transformer is 1A.

Alarm contacts max 1A 230Vac not protected by internal fuse.

Make a good connection of the ground of CF5 to the burner mass to ensure correct operation.

## MESSA IN SERVIZIO

1. Open the gas valve.
2. Start the system.
3. Give power to the CF5.
4. Press the power button (green power LED lights up).
5. Switch on the enable terminal to start the ignition cycle.
6. Waiting time at the start of about 5sec.
7. After this time the CF5 will carry out the ignition cycle. The gas solenoid valve will be commanded and the discharge will be carried out at the same time (yellow discharge LED will light up). At the end of the discharge the presence of the flame will be checked.
8. In its presence, the equipment goes into operation by turning on the green detection LED and continuing to power the solenoid Gas valve.
9. Otherwise CF5 will go into lockout (the gas solenoid valve will be disconnected, the alarm contact will close and the red lock LED will light up). To reset it and retry the boot it will be necessary to switch it off and switch it on again using the power button.

**N.B.** The terminal box  should never be used. This clamp has remote unlocking functionality and must be used only by authorized personnel, keeping the burner to be re-ignited under strict control.

## OPERATION CHECK

1. Remove the detection plug during operation.
2. **CF5** will attempt to restart only once, after which it will be shut down due to an anomaly (the gas solenoid valve will be disconnected, the alarm contact will close and the red LED will light up).
3. The burner flame must go out.
4. If a different operation should occur check the wiring. This done if the problem has not been resolved disassemble the **CF5** and send it to the manufacturer for a complete overhaul.

After replacing the safety device, check its operation:

- Close the general gas valve and check that the appliance, after a few attempts, does not start.

If the safety device works correctly and the wiring is in order but the equipment attempts to start the burner, send it to the manufacturer for a check.

## OPERATING MODES GRAPHS

Ta => waiting time before starting  
 (pre-purge Time)

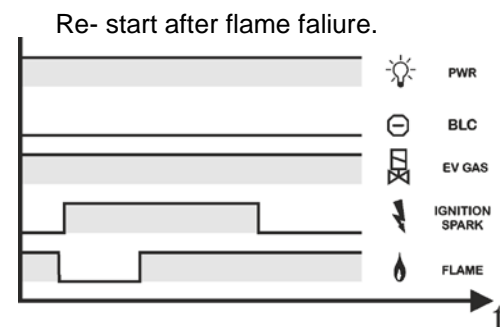
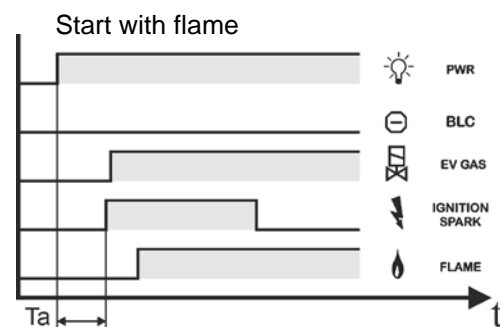
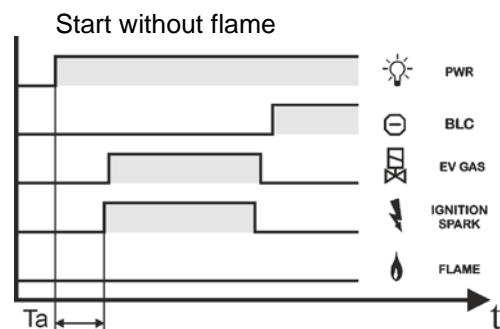

On **CFS** it is possible to set some functions and some values through 8 microswitches housed on the on-board electronic board. The basic configuration of microswitches is all 0

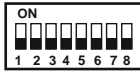

**TIMES SETTINGS**

Pre Purge Time setting

Pre Purge 5 sec	
Pre Purge 1 sec	
Pre Purge 8 sec	
Pre Purge 10 sec	
Pre Purge 20 sec	
Pre Purge 30 sec	
Pre Purge 50 sec	
Pre Purge 70 sec	

Ignition Time setting

Ignition Time 5 sec	
Ignition Time 12 sec	

Safety Time loss of Flame

Safety Time 2 sec	
Safety Time 3 sec	

**FUNCTIONS SETTINGS**

Attempt to re-ignite after loss of flame

Yes		No	
-----	--	----	--

Ignition/re-ignition attempts numbers

N° 1		N° 3	
------	--	------	--

Detection flame circuit 24h self check

Enabled	
Disabled	

Self check OK

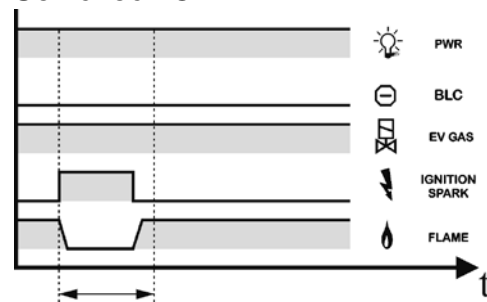

Self check No flame detection

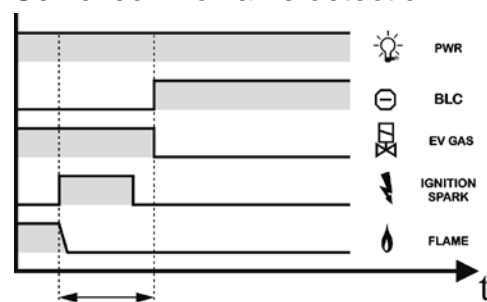

Self check No flame detection

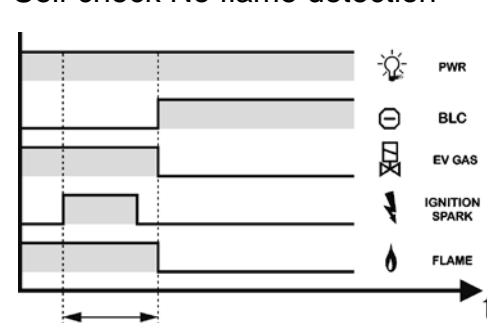

Operation display

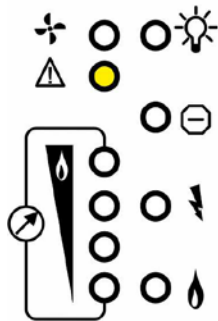

OFF +  
Power Supply

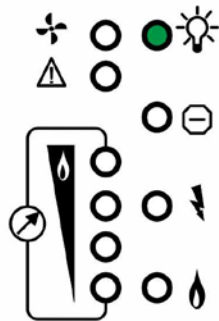

Power Supply



Power Supply  
+ enabled



Burner  
Ignition

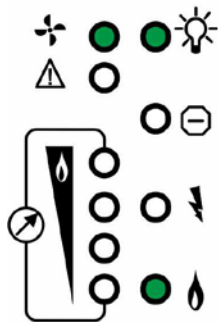

Flame detected  
Ev Gas ON

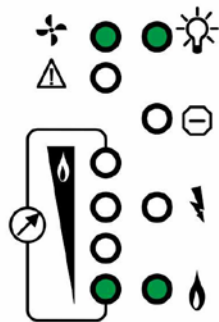

Flame detected  
Flame Signal  
over 5µA

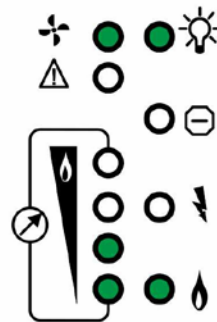

Flame detected  
Flame Signal  
over 10µA

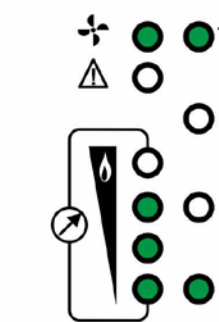

Flame detected  
Flame Signal  
over 15µA

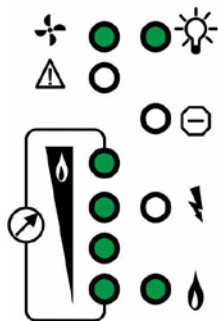

Flame detected  
Flame Signal  
over 20µA

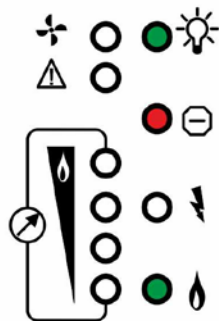

Fault Block  
Illegal Flame

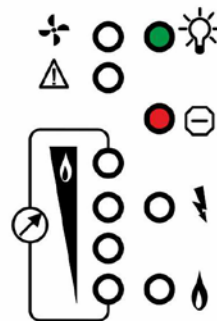

Fault Block  
Lost Flame

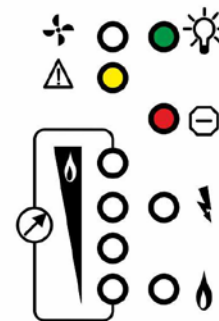

Remote Command  
Pulse Unlock



## RETIFICATION OF FAULTS

### CAUTION!!!

**Danger of death due to shocks!**  
Before intervening on the appliance cut off the tension to any cable.

The elimination of breakdowns can be carried out by authorized personnel only.

In case of improper repairs or incorrect electrical connections, the good running of the appliance is not granted.

The release at distance can be carried out only by authorized personnel keeping under strict control the burner to be lighted

? < TROUBLE >  
! < CAUSE >  
\* < REMEDY >

? THE IGNITION SPARK DOES NOT APPEAR.

! The distance between the electrode and the burner body is too great.

\* Set a distance of max. 2 mm.

! The igniter cable does not make contact with the pipe.

\* re-screw the pipe tightly.

! The igniter cable has a leakage on the earth.

\* Check the laying of the cable, clean the ignition electrode.

! The ignition voltage is too low.

\* use an ignition transformer with power > 5 KV

! The ignition cable is too long.

\* Shorten its length to 1 m. (max. 5 m.)

! The igniter cable does not make contact.

\* Screw it tightly on the ignition transformer.

? THE GAS DOES NOT REACH IT

! The gas solenoid valve does not open

\* Check the solenoid valve connection.

! There is still presence of air in the gas hosepipe.

\* Make many ignition attempts in order to fill completely the gas hosepipe.

? THE GAS DOES NOT REACH IT AND THE IGNITION SPARK DOES NOT APPEAR, THE CF3 DOES NOT START.

! Short circuit in the ignition or in the solenoid valve outlet.

\* Check the wiring

- in case of short circuit in outlets eliminate it and change the inner fuse (2,5 A). Or send the appliance to the manufacturer.

? THERE IS THE FLAME BUT THE DETECTION LED IS OFF.

! The detection electrode is in short circuit because of dirt, soot or damp.

! The detection electrode is not in a correct position as to the flame.

! The combustion air/gas ratio is incorrect.

! The flame makes no contact with the burner body because air and/or gas pressure is too high.

! The burner or **CF5** are not earthed correctly.

! Short circuit or detection cable interruption.

! Phase and neutral wire inverted.

\* Eliminate the defect.

? THE APPLIANCE DOES NOT PERFORM THE IGNITION CYCLE AND GOES IMMEDIATELY IN DETECTION.

! Anomaly on the detection (flame simulation)

\* Eliminate the cause of the flame anomaly.

! Anomaly of the flame detection circuit.

\* Send the appliance to the manufacturer for its replacement.

? THE APPLIANCE DOES NOT START EVEN IF ALL THE TROUBLES HAVE BEEN ELIMINATED AND THE MAIN SWITCH HAS BEEN PRESSED.

\* Send the appliance to the manufacturer for the functional inspection.



**AUTOMATIC BURNER CONTROL UNIT CFS SERIES**  
MONO - DOUBLE ELECTRODE FLAME DETECTION  
IN ACCORDANCE WITH STANDARD EN 298

**NOTES**

Lined area for notes with horizontal lines on both sides.



## WARRANTY

Saitek Co. Ltd warrants these appliances to be free from defects in material and workmanship for 12 months from the date of their installation up to a maximum of 18 months from the date of their original purchase by a consumer, provided that the appliances are properly used in accordance with their operating instructions and applications.

## SAITEK srl

Via IV Novembre n° 4  
42013 Casalgrande (RE) ITALY  
<http://www.saitek.it> e-mail [info@saitek.it](mailto:info@saitek.it)  
Tel. 0522.848211 fax 0522.849070